

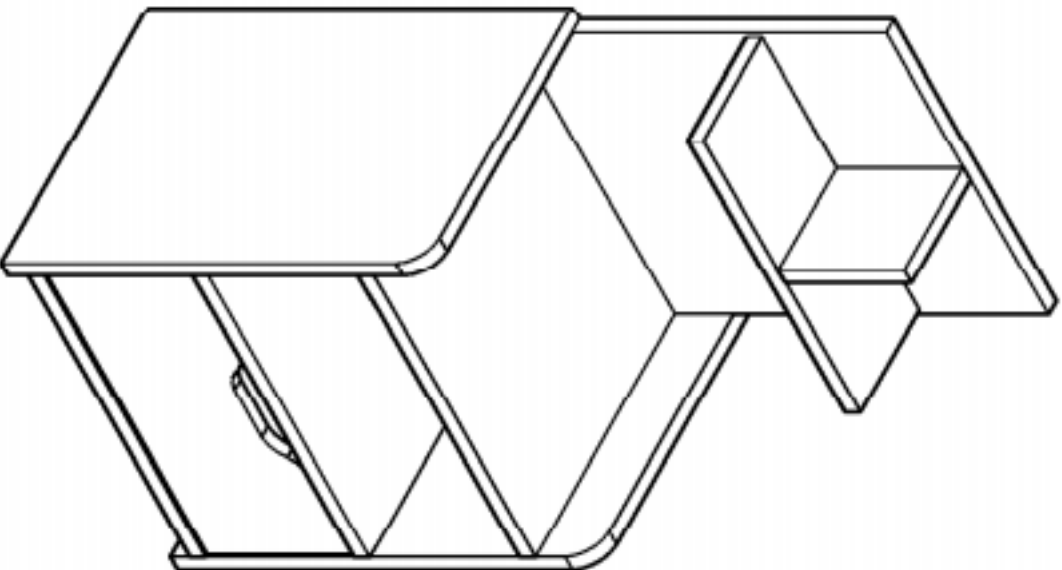

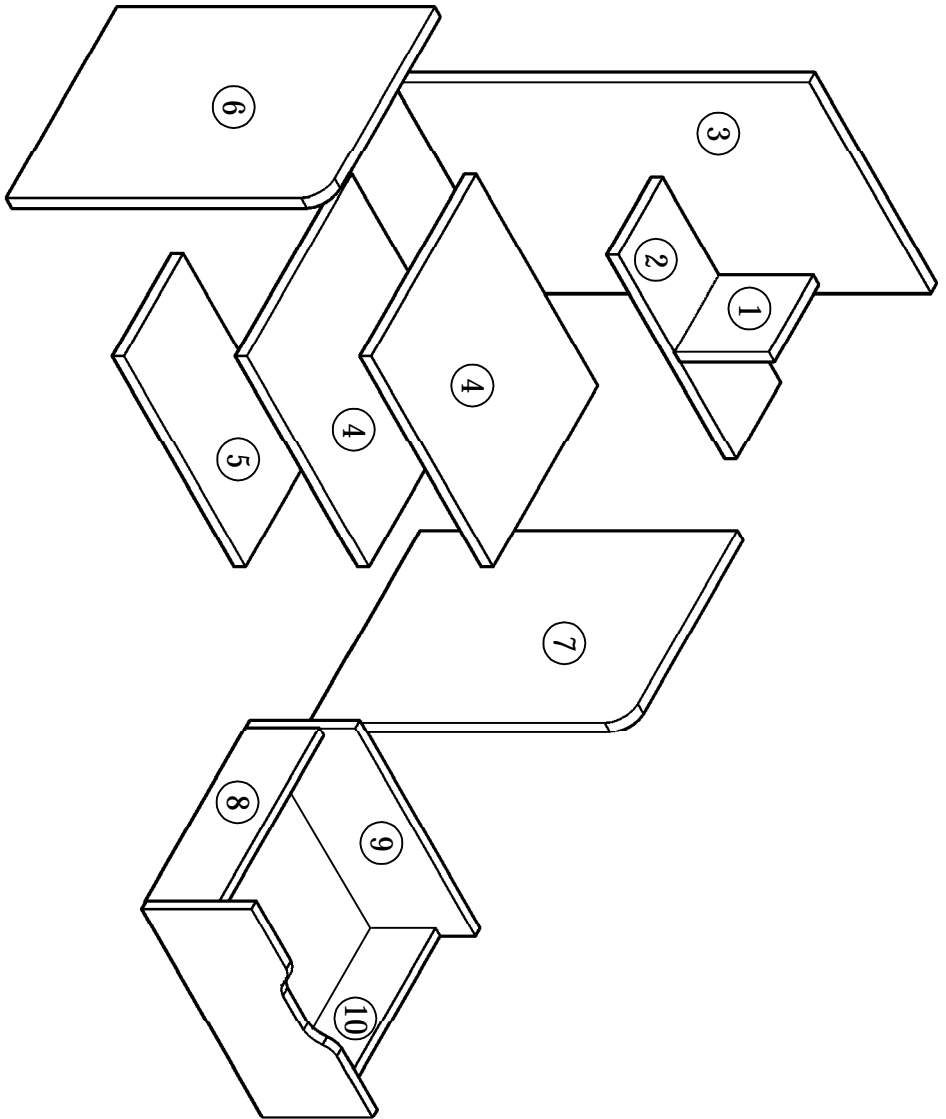

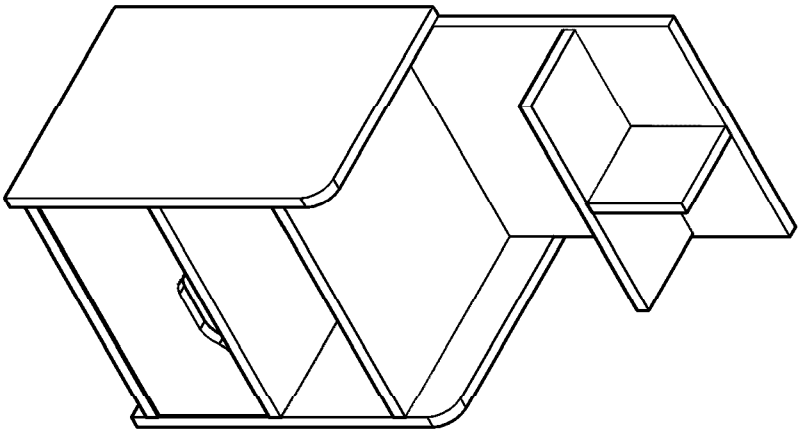

Code : 22051 & 22052

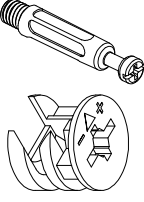
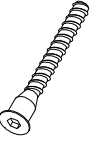

⚠ Warning Warning - Any furniture that is not anchored to a wall has the potential to tip over in certain circumstances, ie if a child attempts to climb up on the furniture or in the event of an earthquake. Accordingly, we recommend that all furniture is anchored to a wall. We supply a free safety wall anchor with all furniture sold and we recommend these are used to prevent your product tipping. See our blog here for more info on using wall anchors.

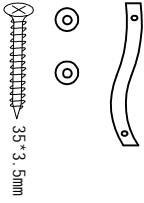

	A 4pcs
	B 25pcs
	C 2pcs
	D 4pcs
	E 4pcs
	F 1pcs
	

1

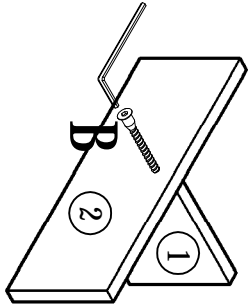

B*1

2

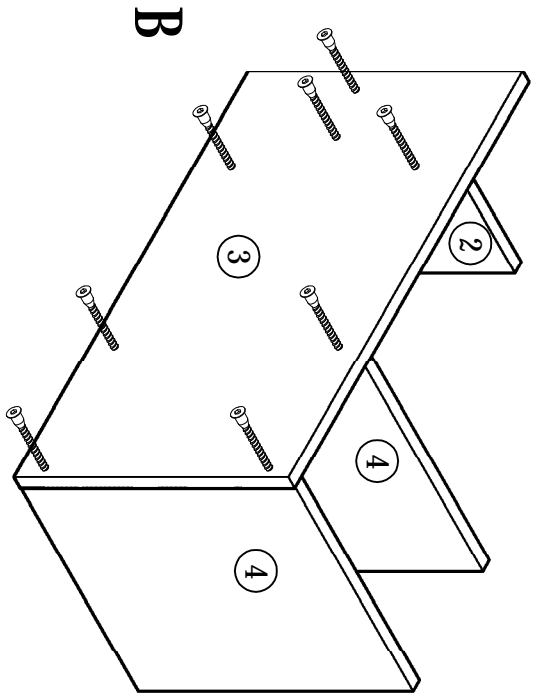

B*8

3

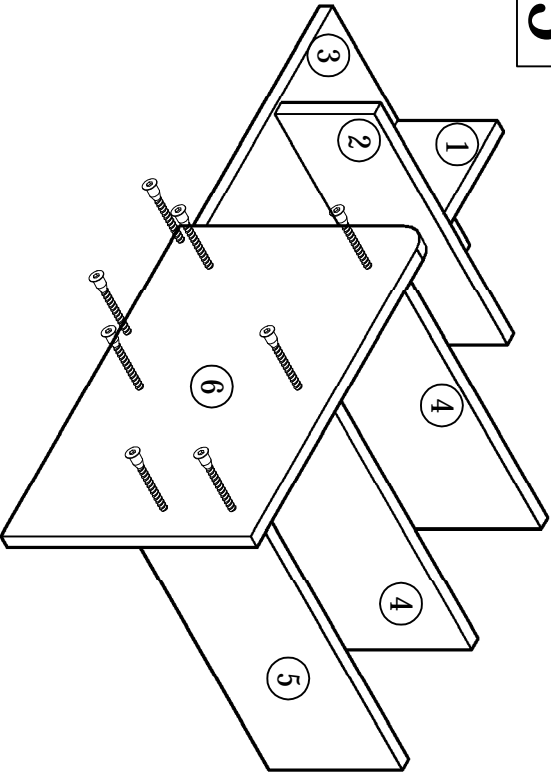

B*8

4

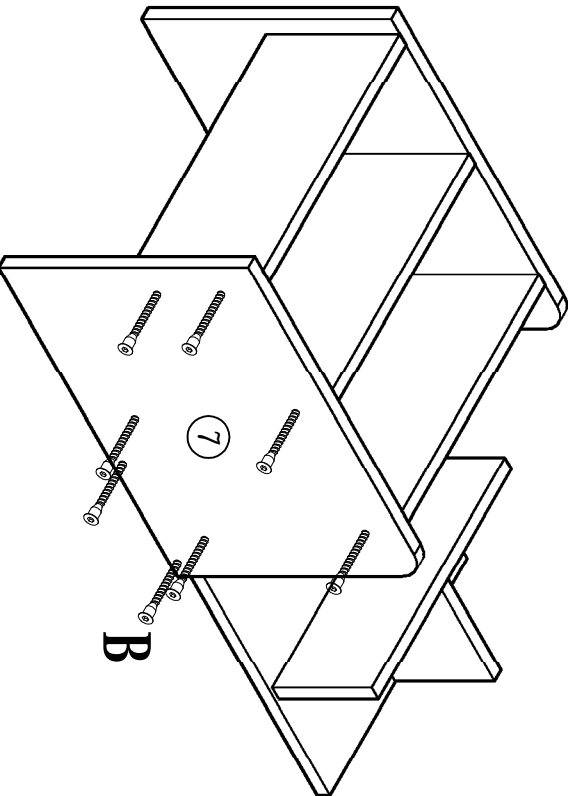

B*8

5

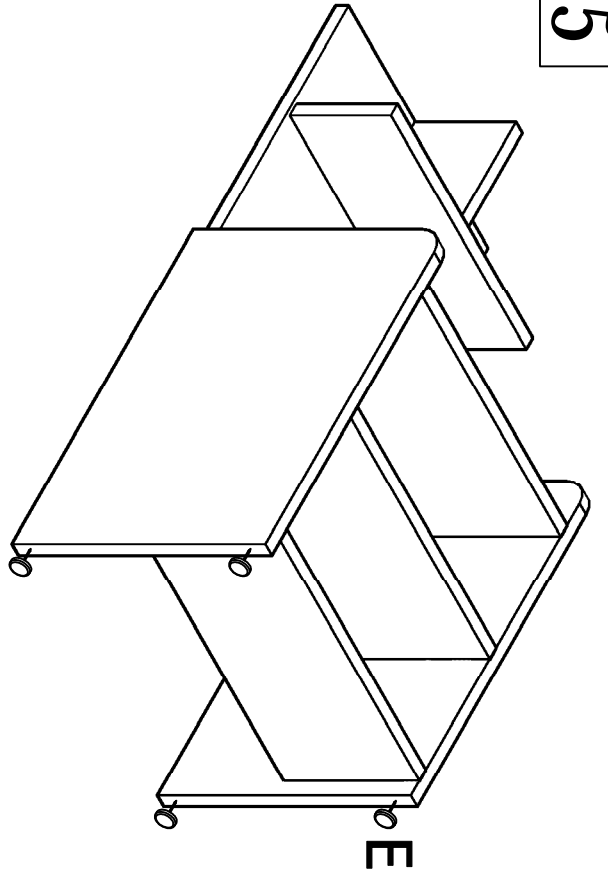

F*4

7

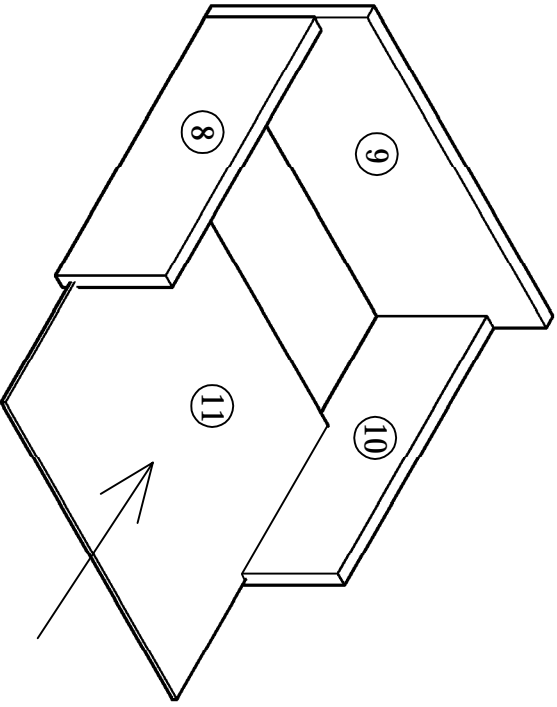

6

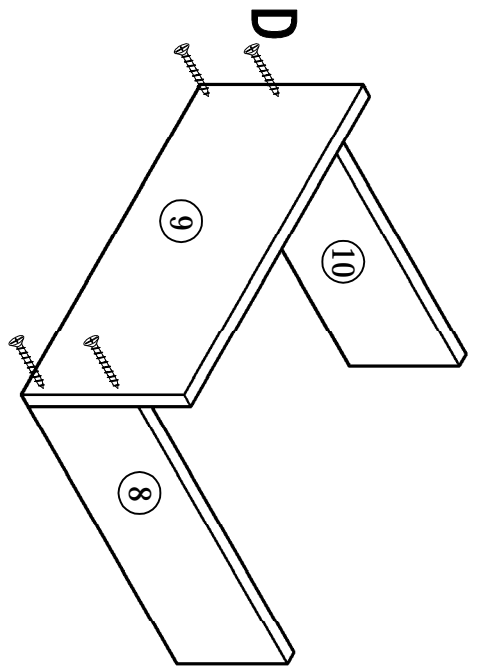

D*4

8

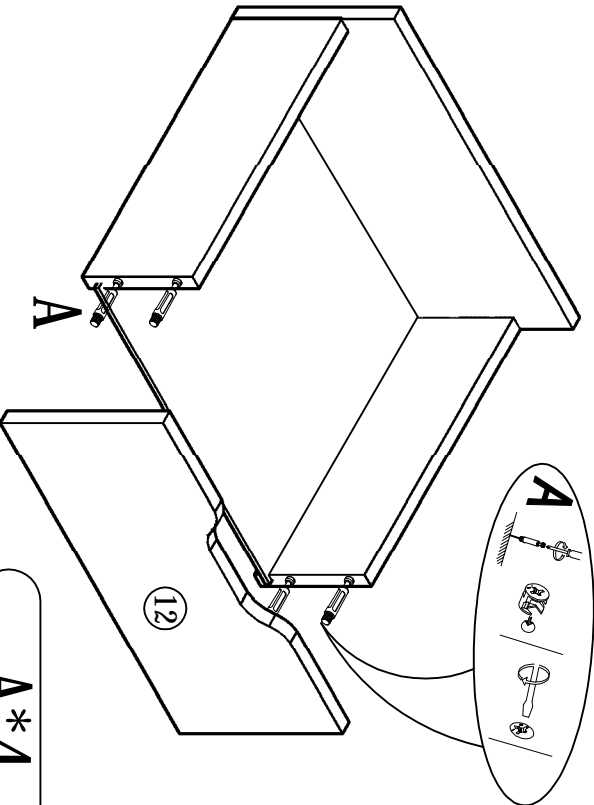

A*4

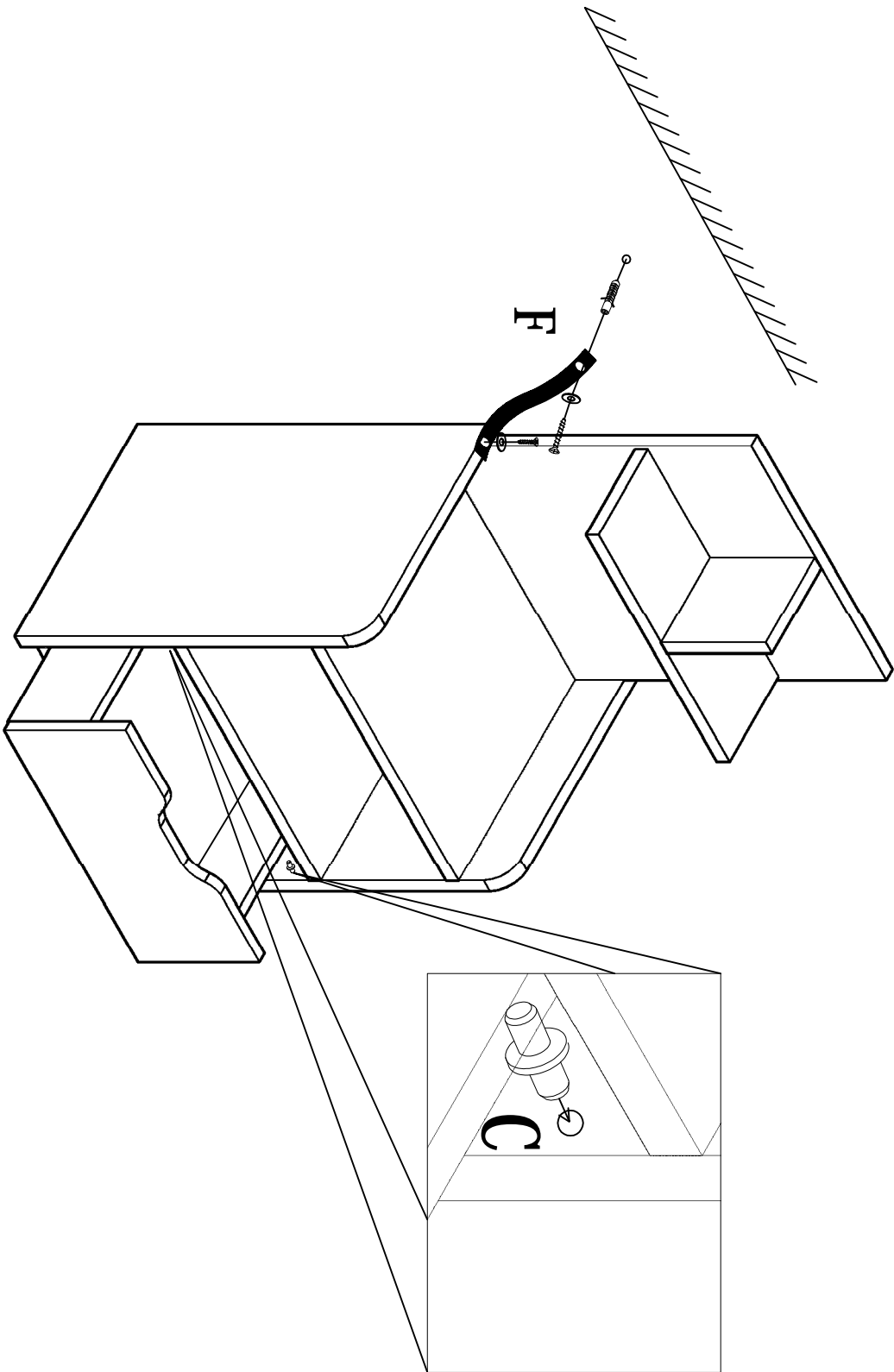

C*2 F*1