

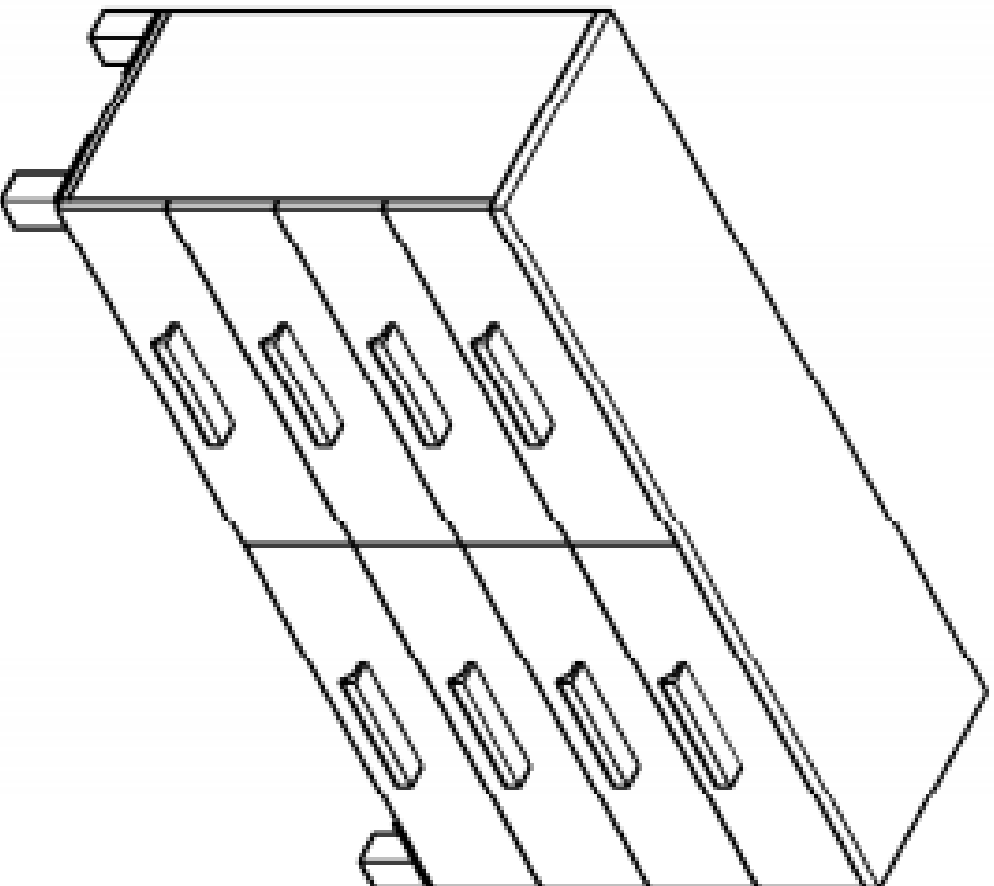







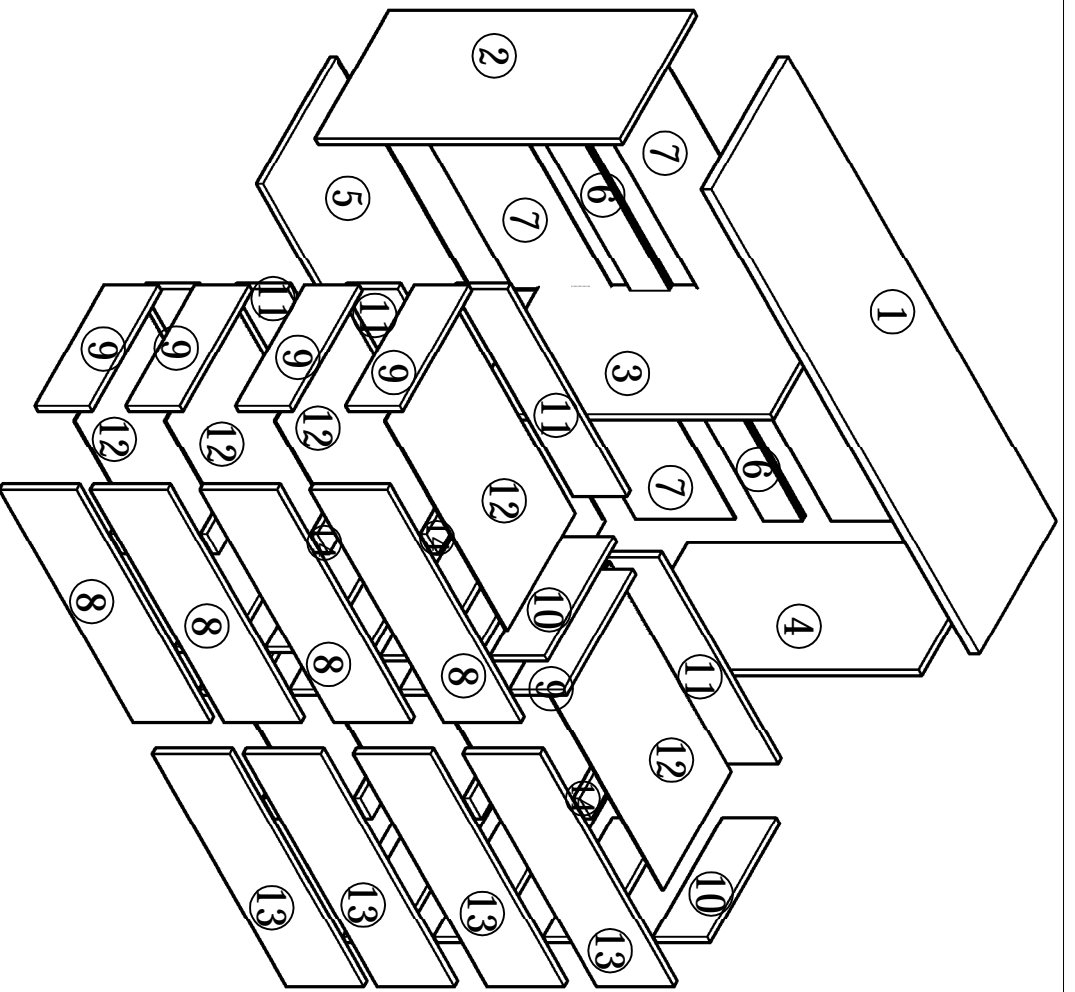
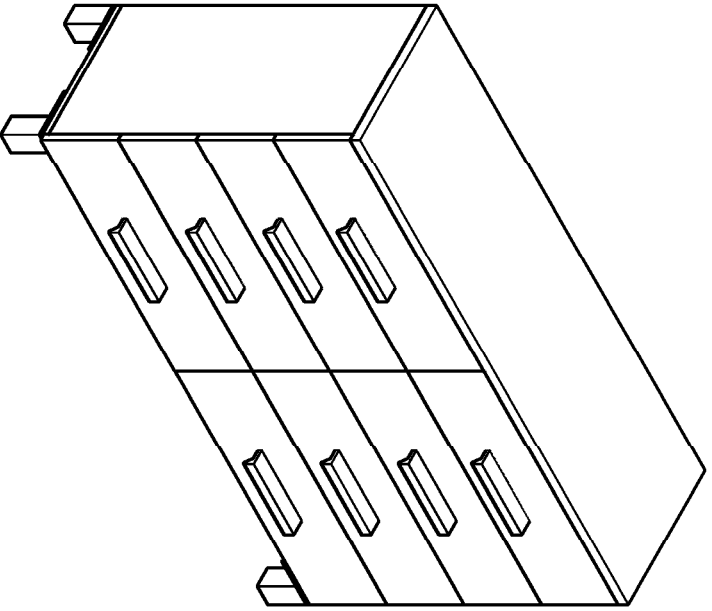
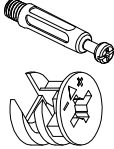
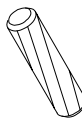

Code : 21994 & 21995

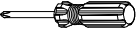
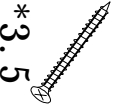

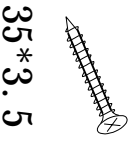
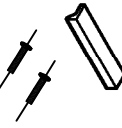
 Warning Warning - Any furniture that is not anchored to a wall has the potential to tip over in certain circumstances, ie if a child attempts to climb up on the furniture or in the event of an earthquake. Accordingly, we recommend that all furniture is anchored to a wall. We supply a free safety wall anchor with all furniture sold and we recommend these are used to prevent your product tipping. See our blog here for more info on using wall anchors.

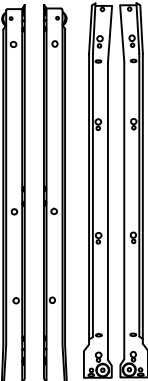
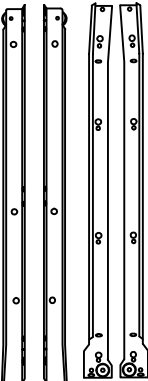

A 	68pcs	B 	9pcs	C 	92pcs	G 	5pcs	H 	1pc	I 	40*3.5 2pcs	J 	32pcs	D 	35*3.5 2pcs	E 	8pcs	K 	8pcs	F 	8pcs	F₁ 	8pcs	L 	68pcs
--	--------------	---	-------------	---	--------------	--	-------------	--	------------	--	------------------------------	---	--------------	---	------------------------------	---	-------------	--	-------------	---	-------------	---	-------------	--	--------------

1

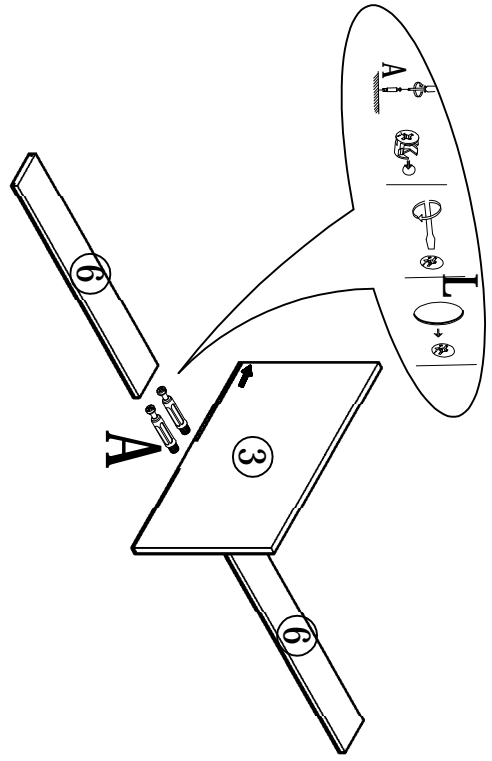

A*4 L*4

2

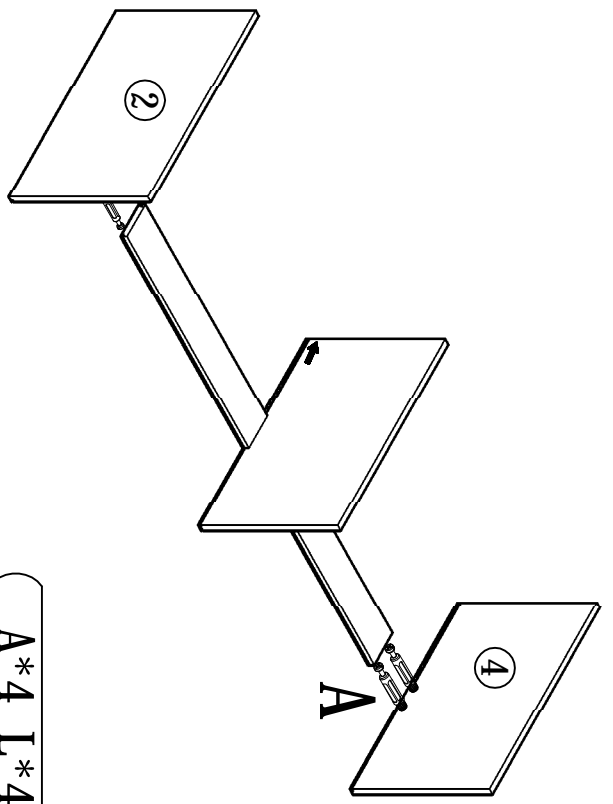

A*4 L*4

3

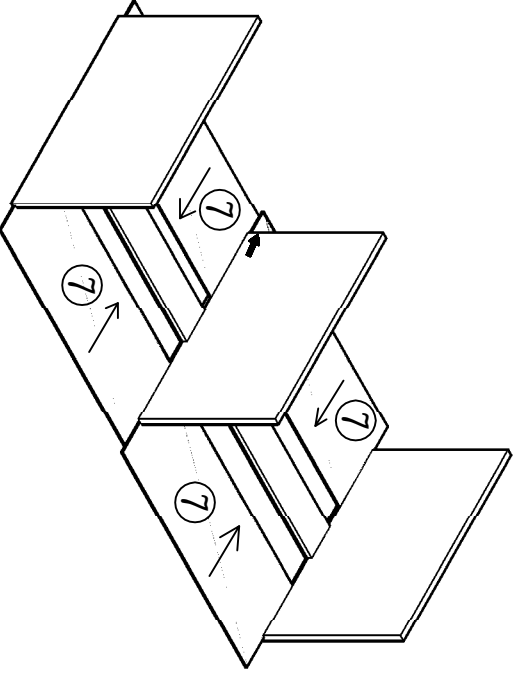

4

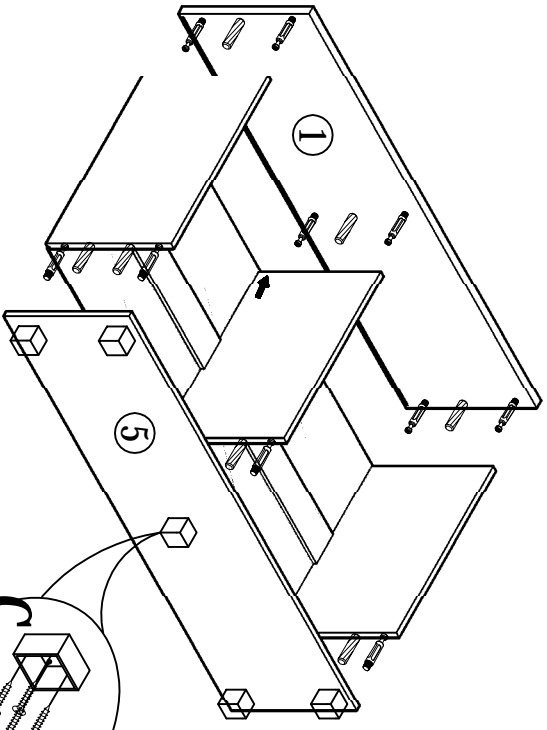

A*12 B*9 C*20 G*5 L*12

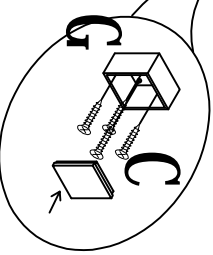

5

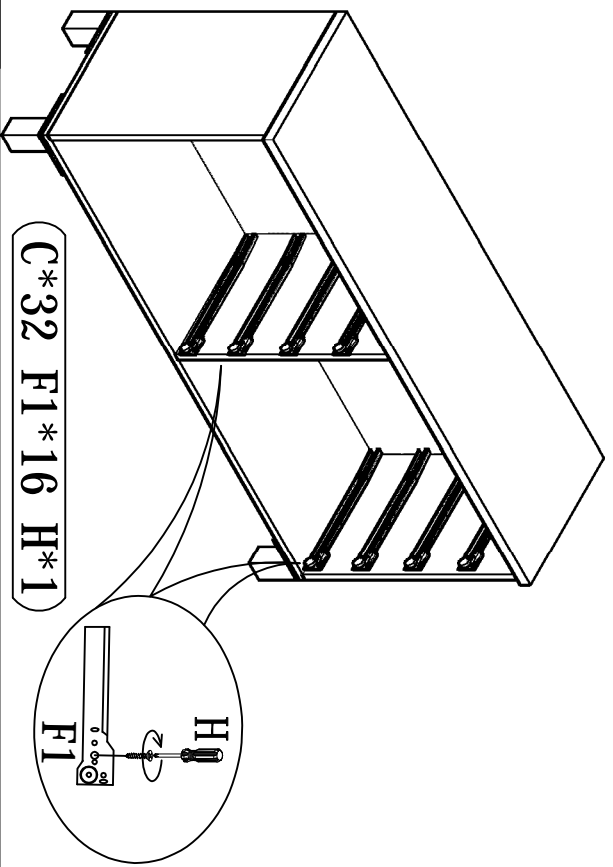

C*32 F1*16 H*1

7

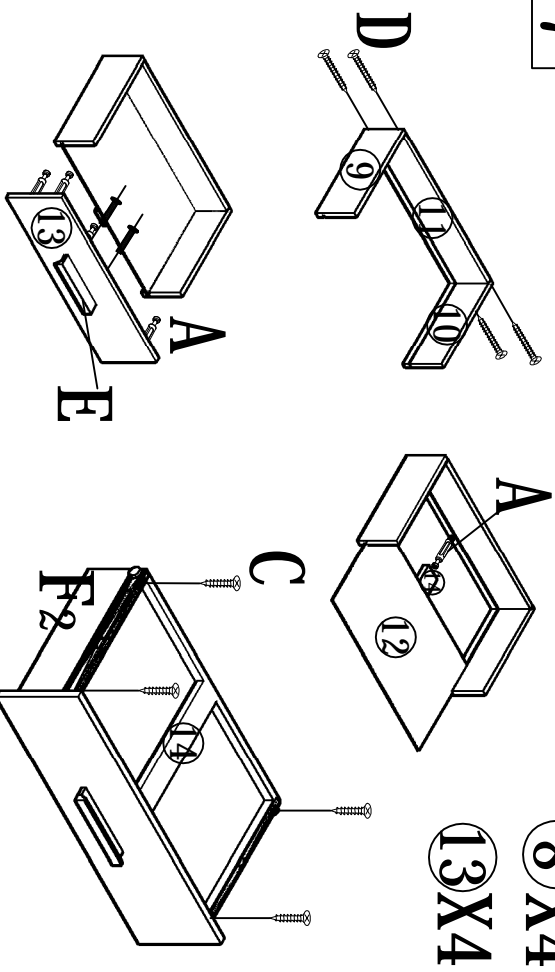

8X4

13X4

A*6 C*4 D*4 E*1 F2*2 L*6

6

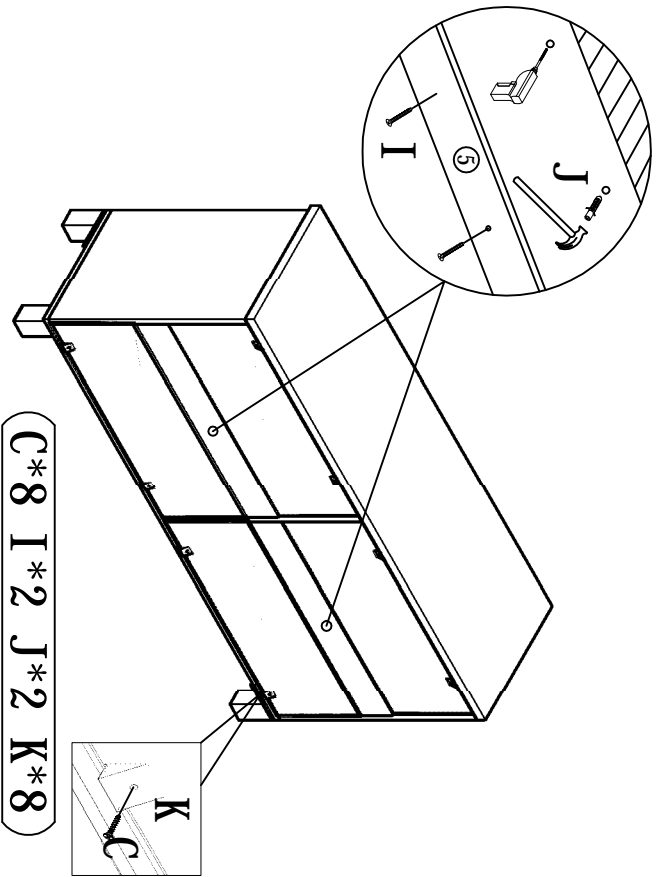

C*8 I*2 J*2 K*8

8

