

3 Drawer Shoe Storage Cabinet Unit

Code: 21978

Assembly Instructions







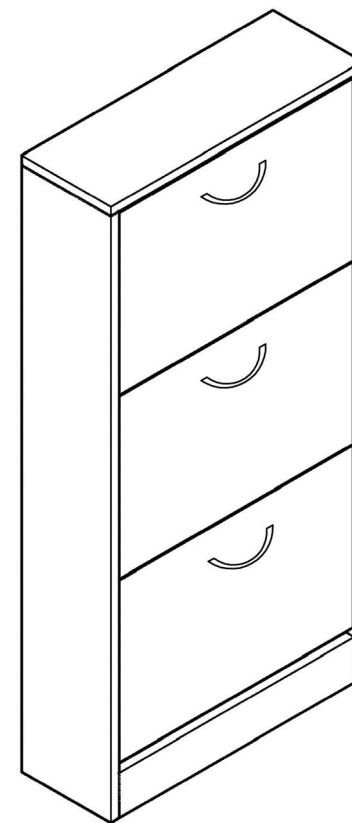

Thank you for your purchase.

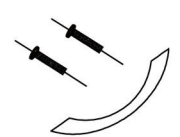
Please follow the instructions below for correct assembly.

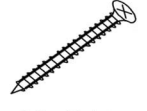
- Quicker assembly, we recommend the use of a power drill on a low-speed setting.
- We strongly recommend that the product is assembled on a flat and smooth surface and keep on the same horizontal line, otherwise, there will be a phenomenon of screw dislocation and cannot be installed.



WARNING: Any furniture that is not anchored to a wall has the potential to tip over in certain circumstances, i.e. if a child attempts to climb up on the furniture or in the event of an earthquake. Accordingly, we recommend that all furniture is anchored to a wall. We supply a safety wall anchor with all furniture sold and we recommend these are used to prevent your product tipping. See our blog here or more info on using wall anchors.

<p>A</p>  <p>25set</p>	<p>B</p>  <p>3pcs</p>	<p>C</p>  <p>14x3.5mm 48pcs</p>	<p>D</p>  <p>40x3.5mm 2pcs</p>	<p>E</p>  <p>4pcs</p>	<p>F</p>  <p>2pcs</p>	<p>G</p>  <p>3set</p>
<p>H</p>  <p>H1 H2 H3 3set</p>	<p>I</p>  <p>25pcs</p>	<p>J</p>  <p>1pcs</p>				

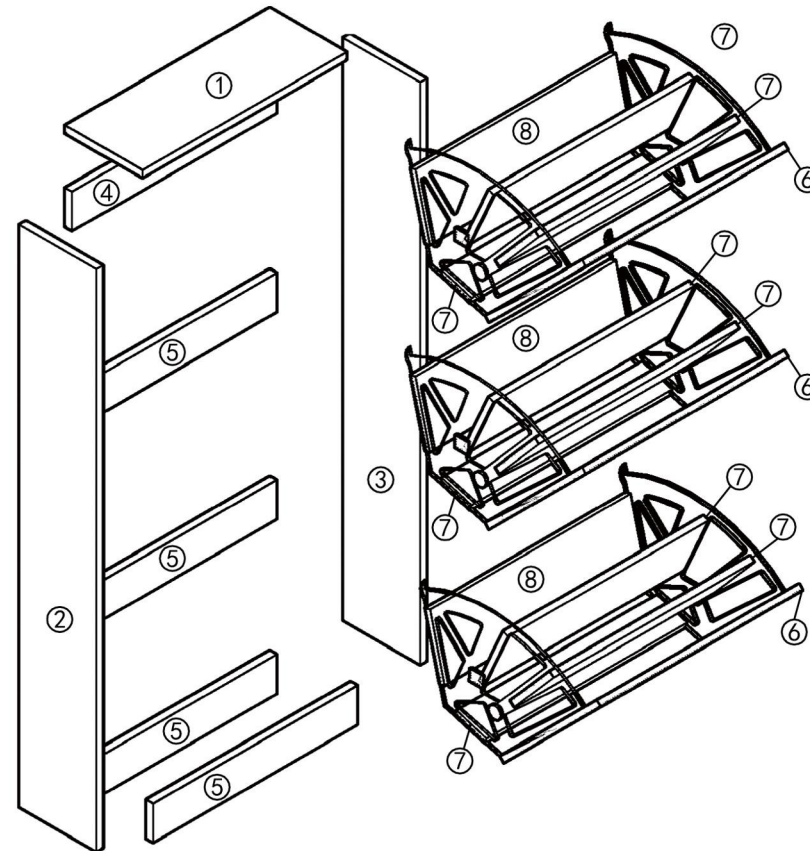
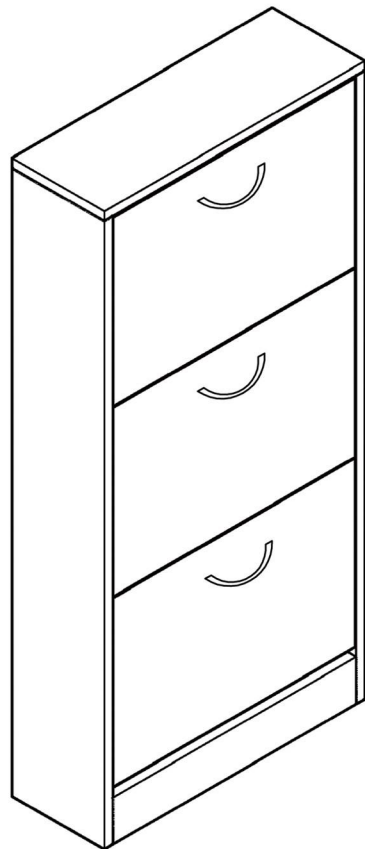

1

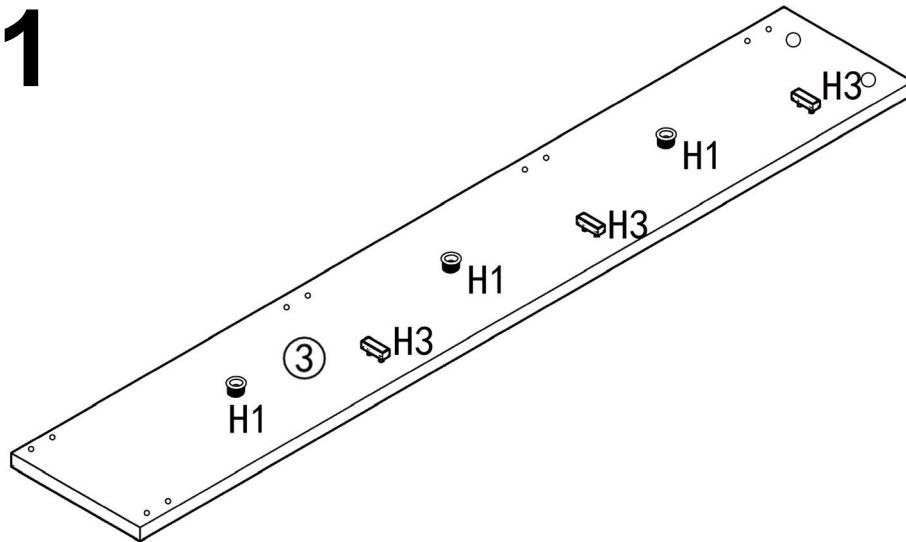

H1 x3pcs H3 x3pcs

2

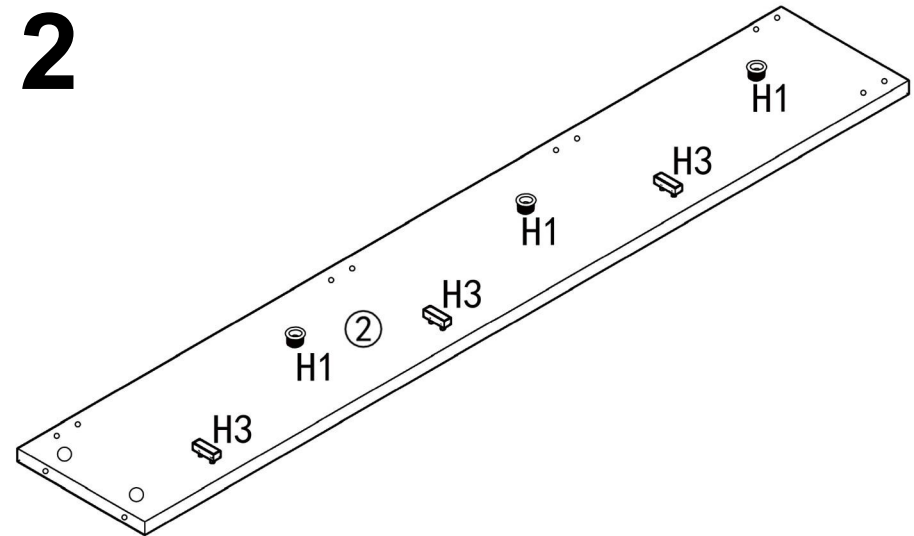

H1 x3pcs H3 x3pcs

3

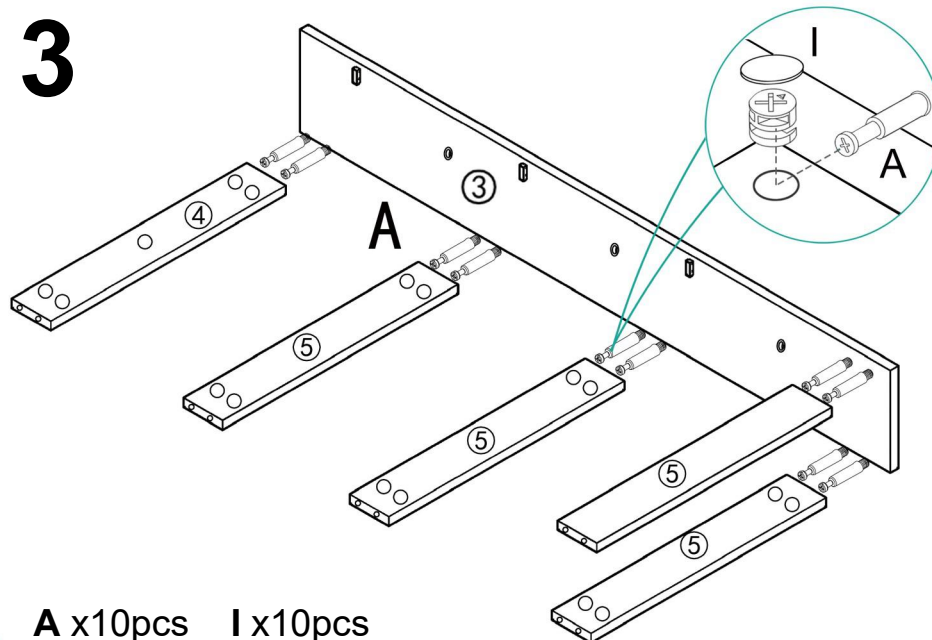

A x10pcs I x10pcs

4

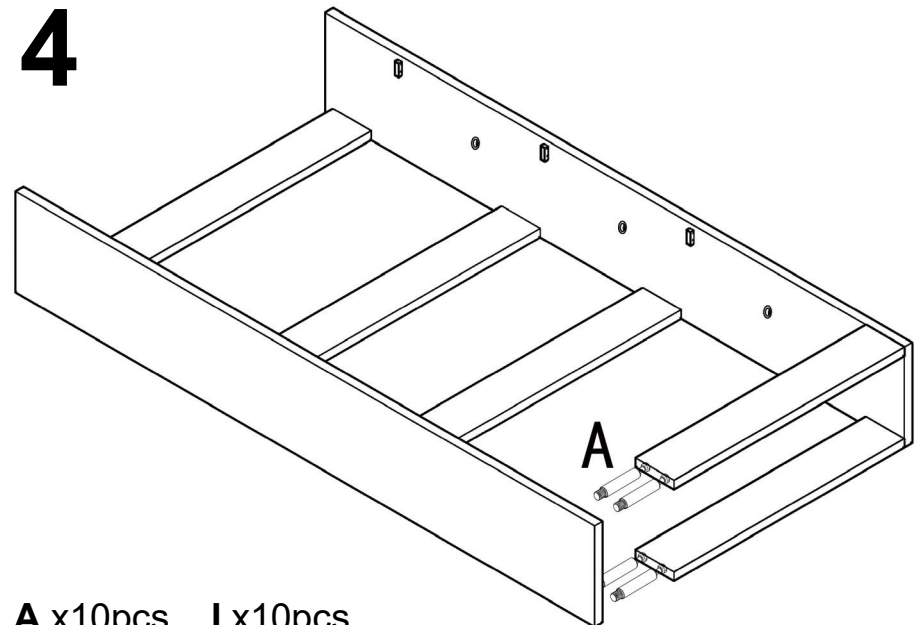

A x10pcs I x10pcs

5

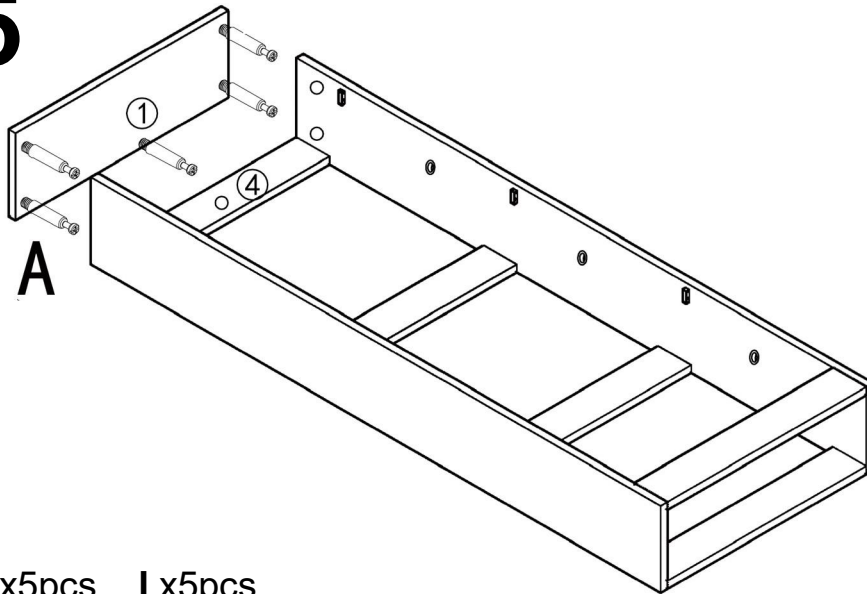

A x5pcs I x5pcs

6

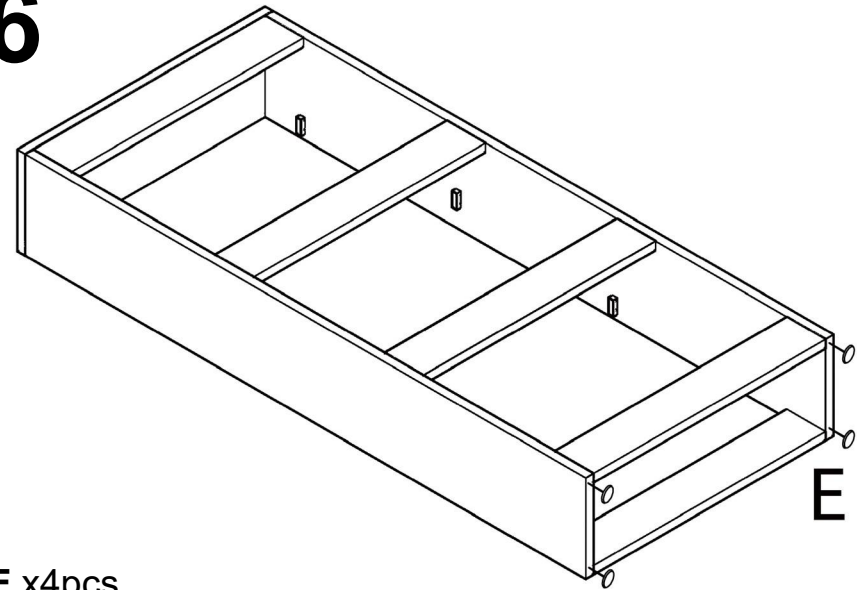

E x4pcs

7

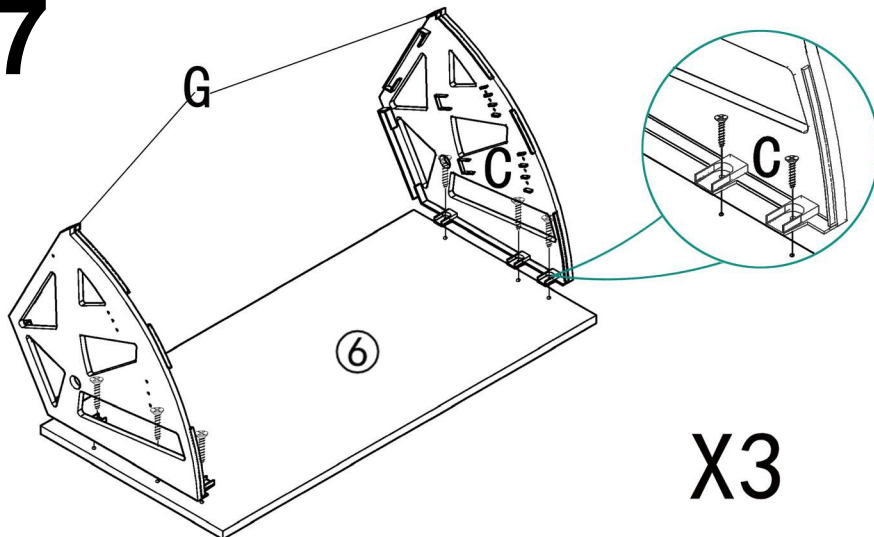

G x1set C x6pcs

X3

8

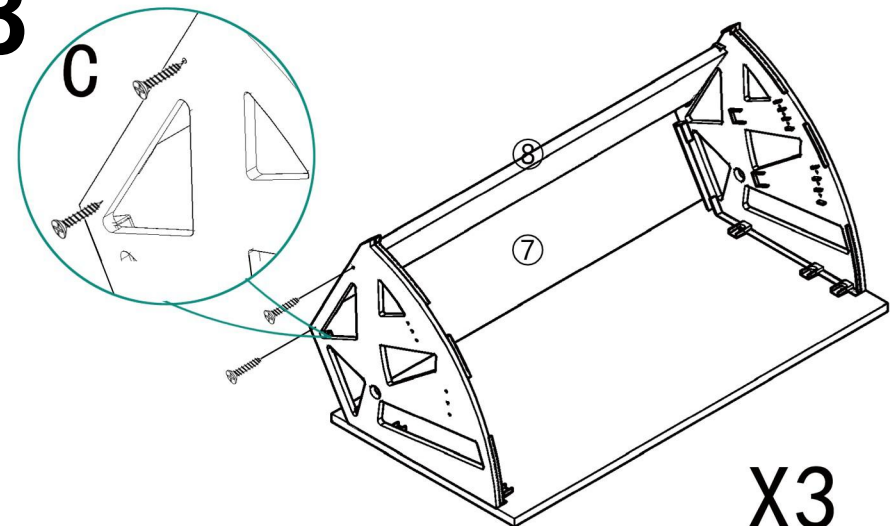

C x4pcs

X3

5

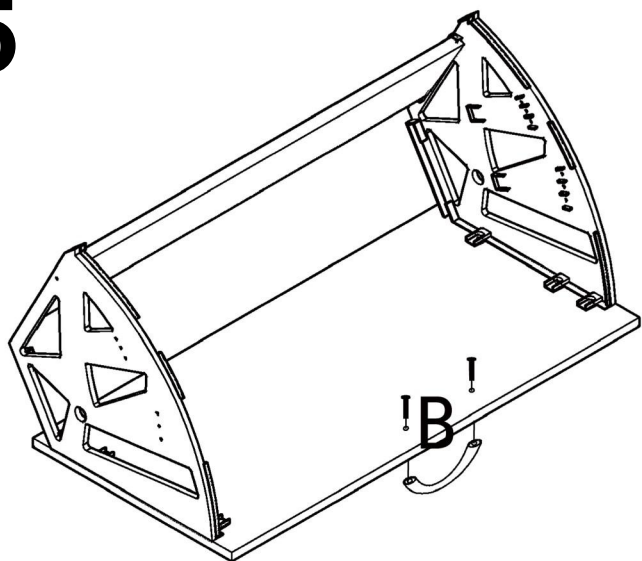

X3

B x1pcs

6

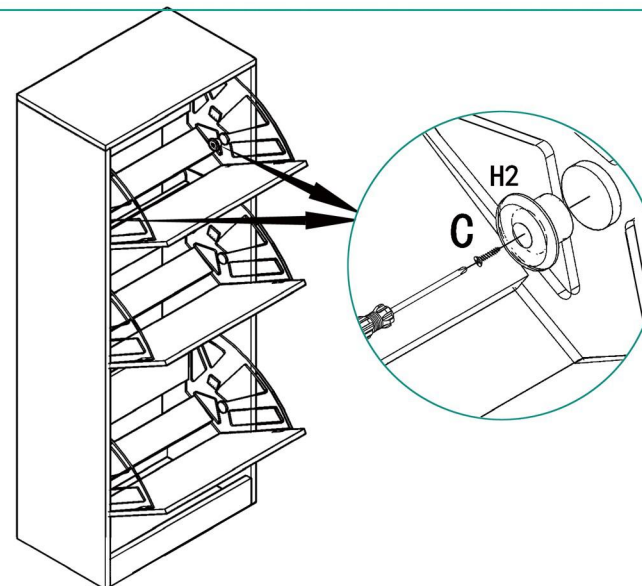

C x6pcs H2 x6pcs

7

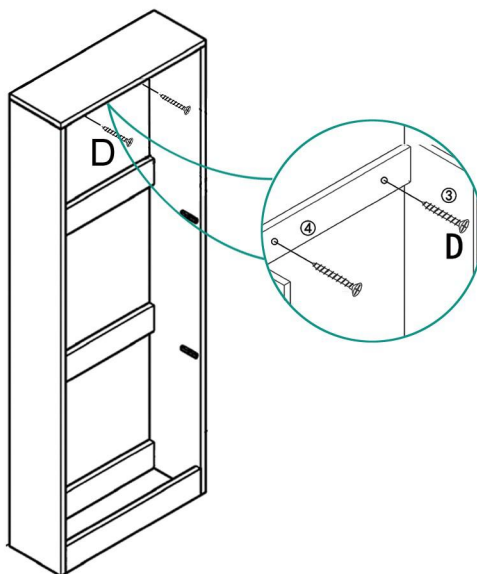
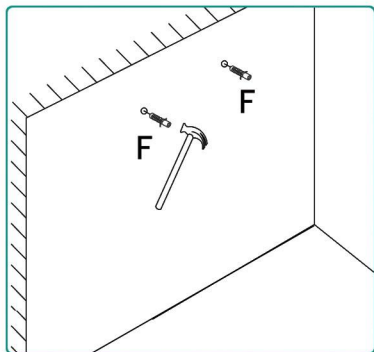

D x2PCS F x2pcs

8

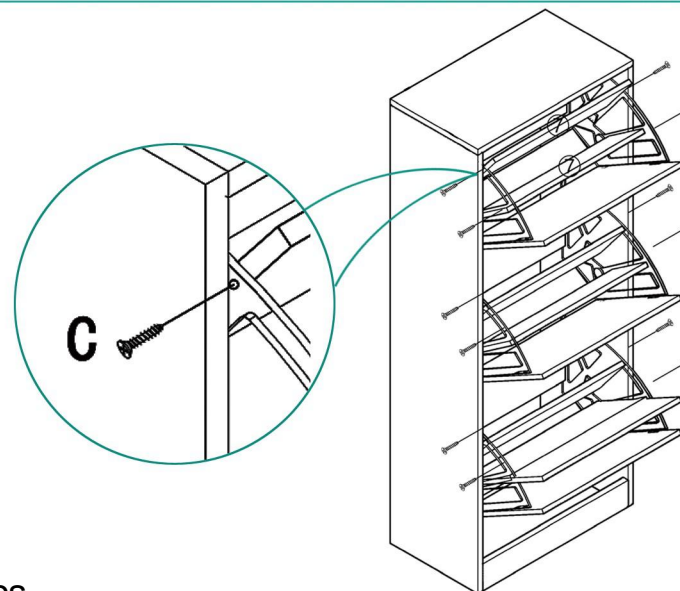

C x12pcs

SURFACE CARE INSTRUCTIONS

A little care and attention will extend the life and good looks of your furniture. Take care when using materials which might spill, or be sharp or abrasive, on the surface of your furniture.

Normal Cleaning: For normal cleaning use a soft, dry, clean cloth.

Glass Cleaning for Frosted Glass: Do not use glass cleaner or solvent based cleaner on glass that has a frosting effect on it.

Normal Glass Cleaning: You may use normal glass cleaning products on all other types of glass. Use a soft non-abrasive cloth to remove light dust and finger prints.

Leather & Vinyl Cloth Cleaning: Under no circumstances should any abrasive materials be used on these surfaces, as it will result in irreparable damage.

Do not use solvents, solvent based cleaners, scouring pads, steel wool or scrubbing brushes to clean this furniture item.

Only use a slightly damp, soft, clean cloth on this surface if cleaning is needed. Do not scrub.

CAUTION

1. When moving this furniture item, please always hold up the product. Dragging or sliding could damage the product itself and the floor surface.
2. As with all furniture, this unit should not be exposed to direct sunlight, extreme temperatures or moisture, as this can result in irreparable damage.
3. Be sure to protect the floor, wall or surrounding furniture with a carpet, blanket or shock-absorbing materials during assembly in order not to damage them.