

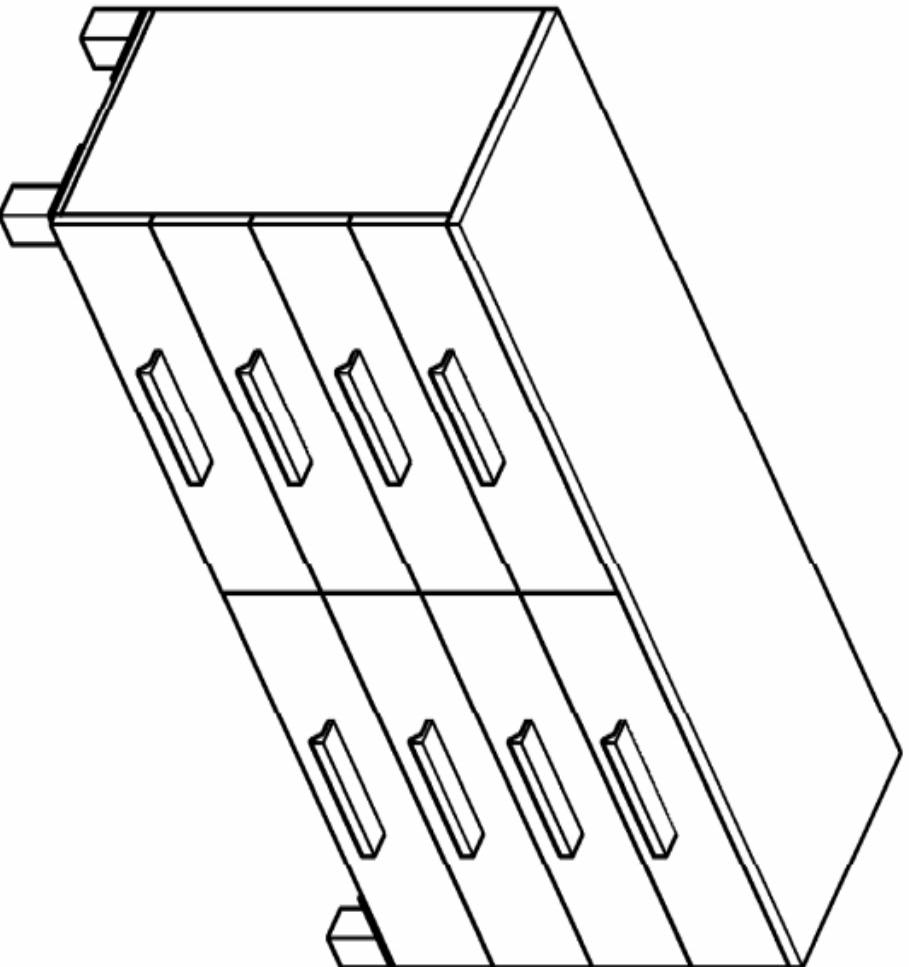









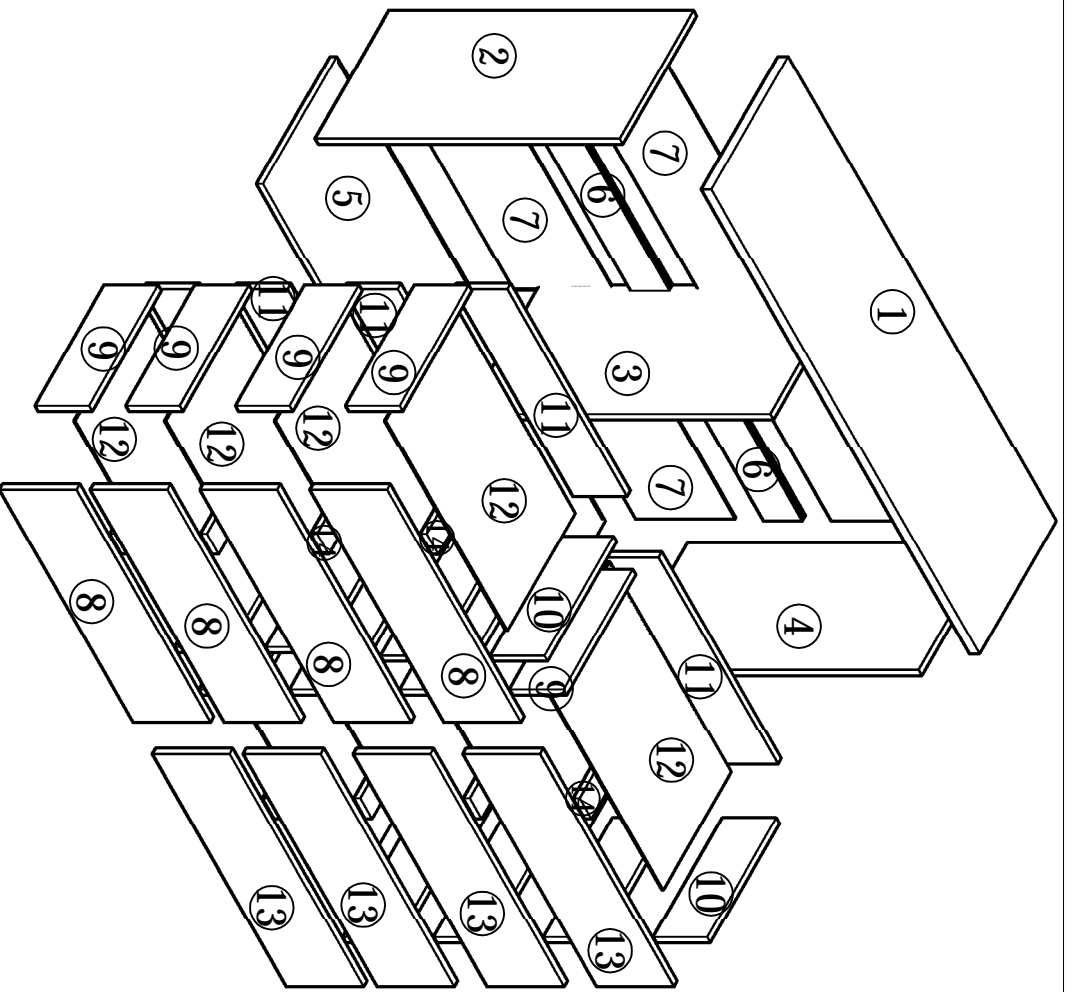
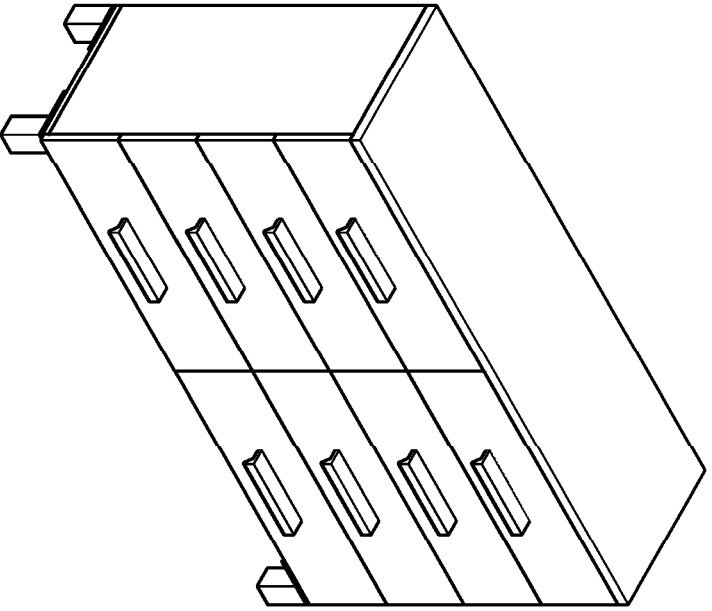
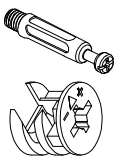
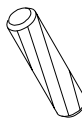

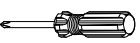

## Code : 21878 & 21895

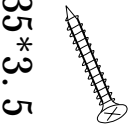

 Warning Warning - Any furniture that is not anchored to a wall has the potential to tip over in certain circumstances, ie if a child attempts to climb up on the furniture or in the event of an earthquake. Accordingly, we recommend that all furniture is anchored to a wall. We supply a free safety wall anchor with all furniture sold and we recommend these are used to prevent your product tipping. See our blog here for more info on using wall anchors.

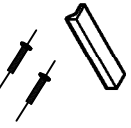

<b>A</b> 	<b>68pcs</b>	<b>B</b> 	<b>9pcs</b>	<b>C</b> 	<b>92pcs</b>	<b>G</b> 	<b>5pcs</b>	<b>H</b> 	<b>I</b> 	<b>2pcs</b>	<b>J</b> 	<b>2pcs</b>	<b>K</b> 	<b>8pcs</b>	<b>L</b> 	<b>68pcs</b>
<b>F<sub>1</sub></b> 	<b>14*3.5</b>	<b>D</b> 	<b>32pcs</b>	<b>F<sub>2</sub></b> 	<b>35*3.5</b>	<b>E</b> 	<b>8pcs</b>	<b>F</b> 	<b>8pcs</b>	<b>F<sub>1</sub></b> 	<b>8pcs</b>					

1

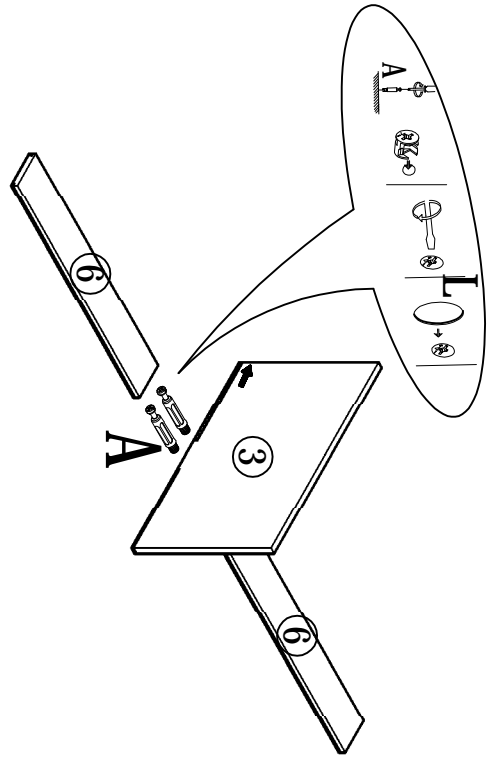

A\*4 L\*4

2

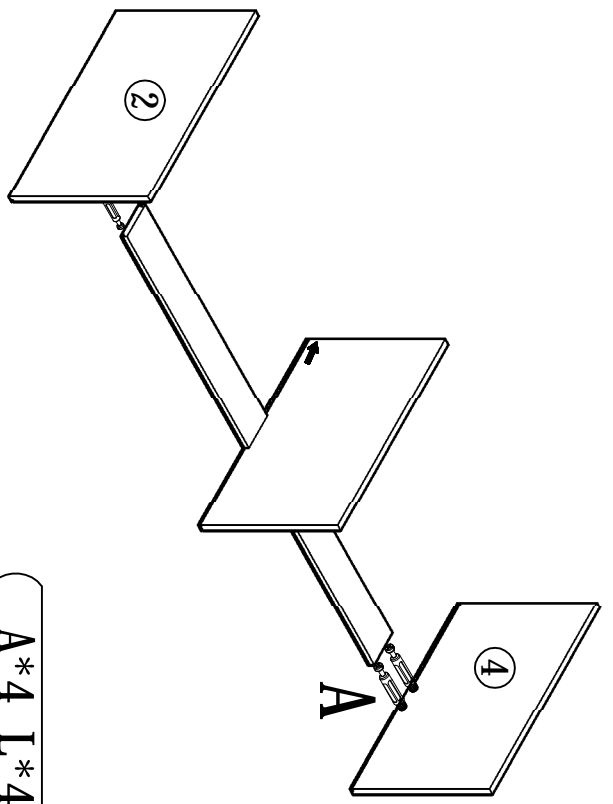

A\*4 L\*4

3

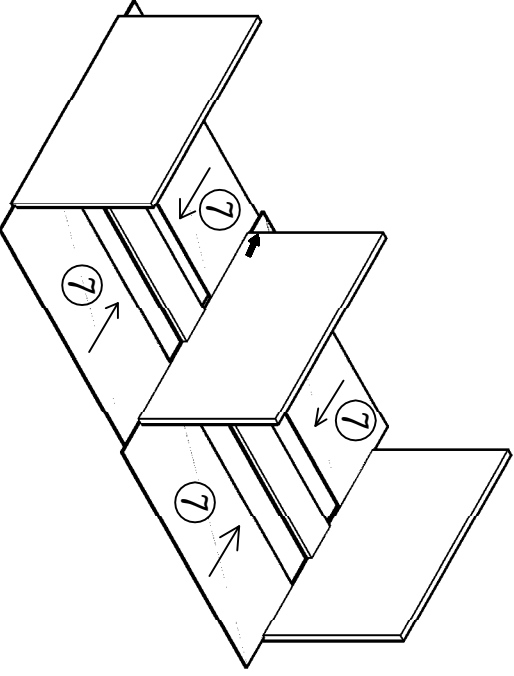

4

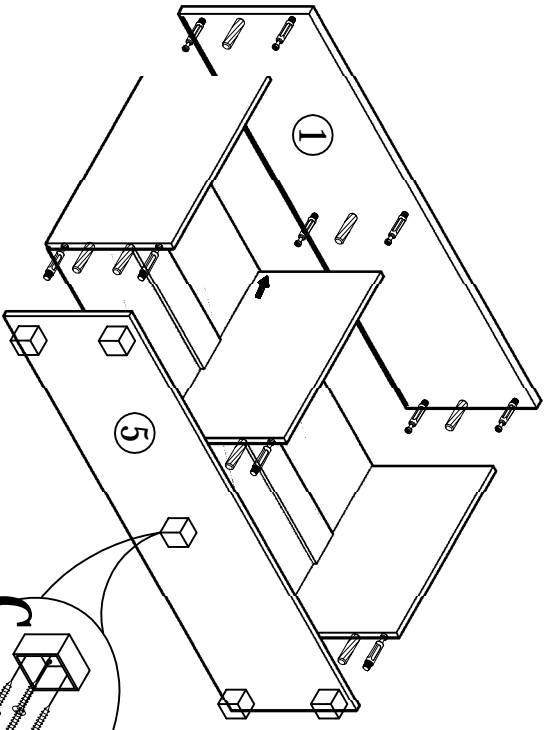

A\*12 B\*9 C\*20 G\*5 L\*12

5

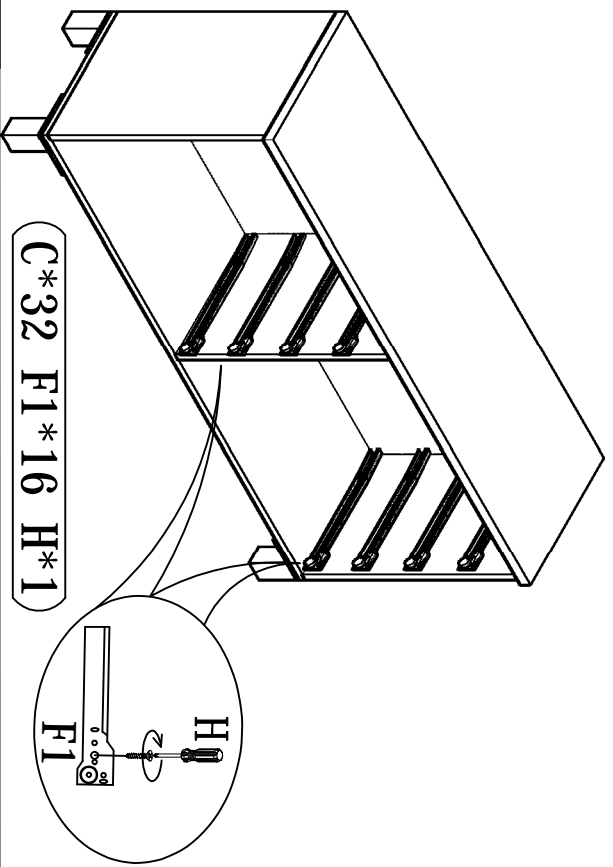

C\*32 F1\*16 H\*1

7

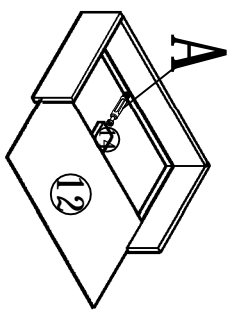
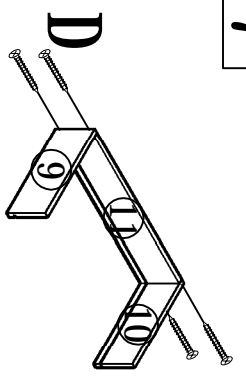

8X4  
13X4

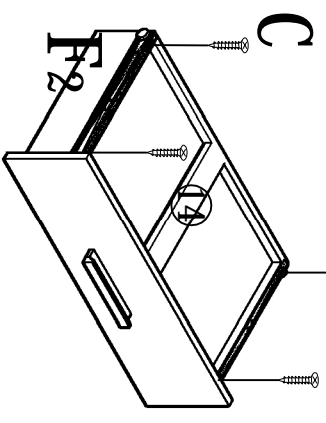
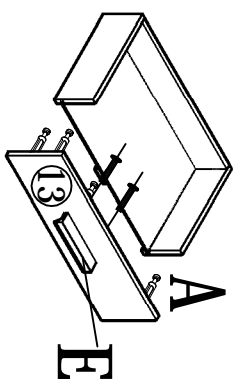

A\*6 C\*4 D\*4 E\*1 F2\*2 L\*6

6

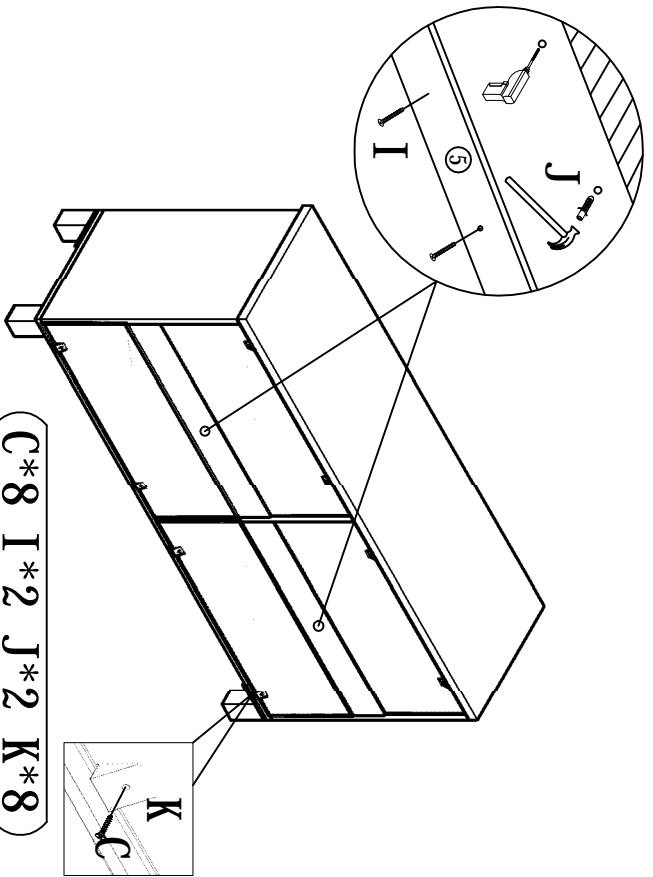

C\*8 I\*2 J\*2 K\*8

8

