

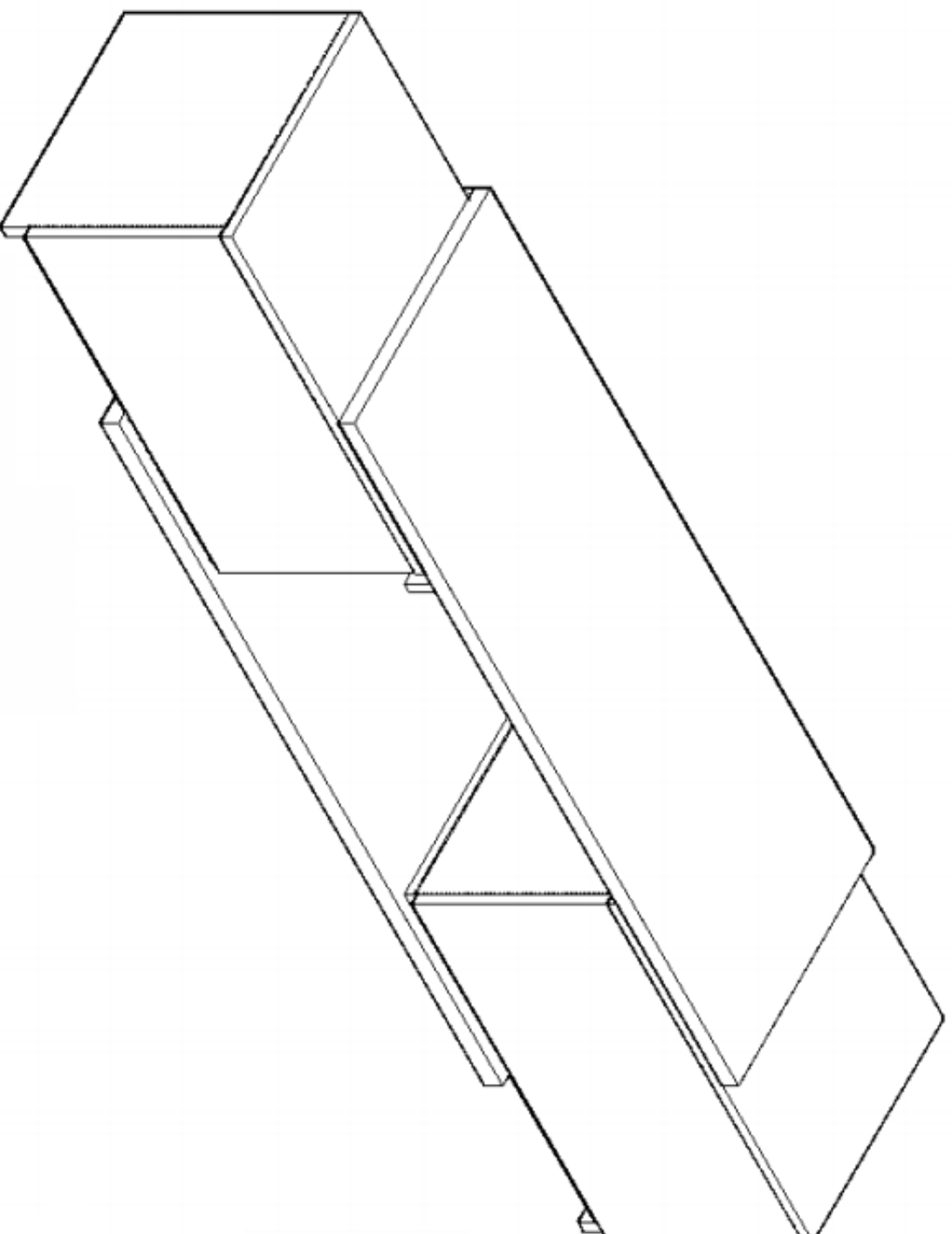

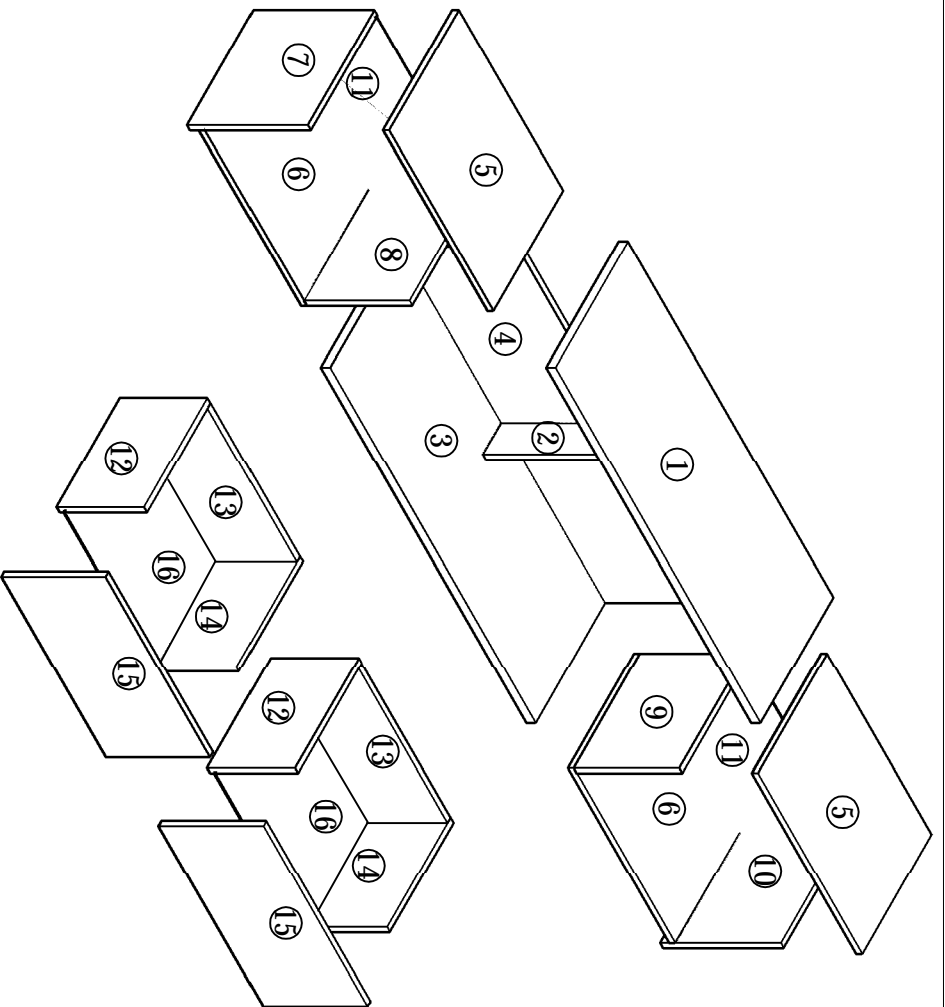

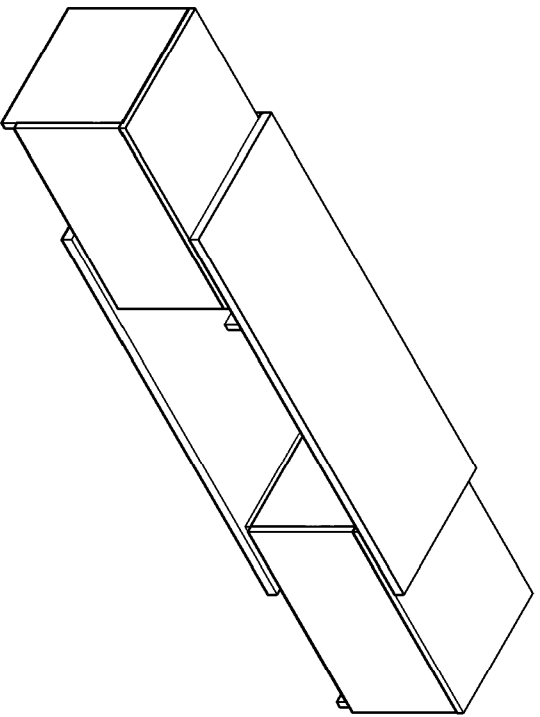
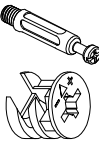
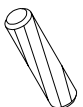
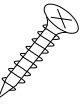

**Entertainment telescopic sets cabinet TV Stand**

**21315**

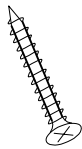

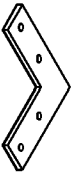

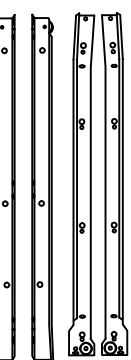
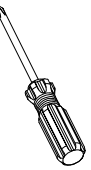
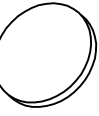
<b>A</b>  38pcs	<b>B</b>  13pcs	<b>C</b>  24pcs 14*3.5	<b>D</b>  16pcs 14*3	<b>E</b>  8pcs 35*3.5	
<b>F</b>  2pcs	<b>G</b>  4pcs	<b>H</b>  4pcs	<b>I</b>  I 1 I 2 24pcs	<b>J</b>  1pc	<b>K</b>  38pcs

1

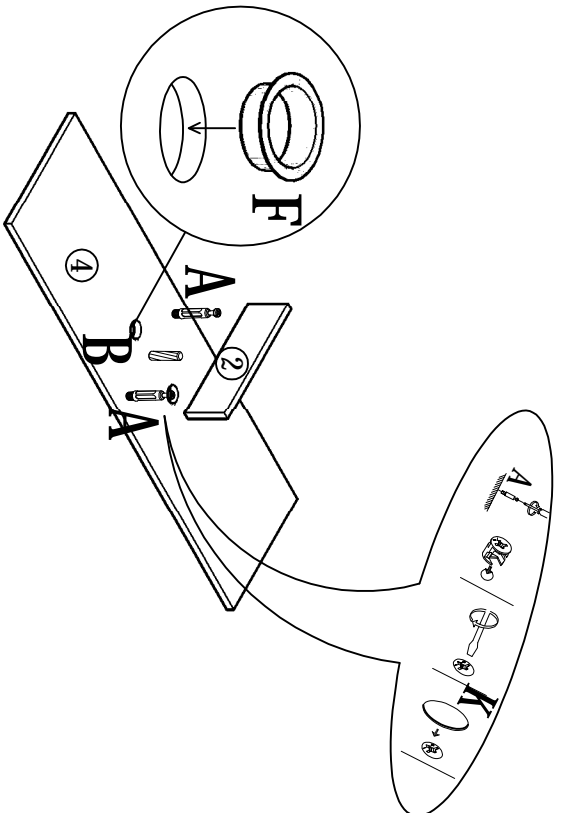

A\*2 B\*1 F\*2 K\*2

2

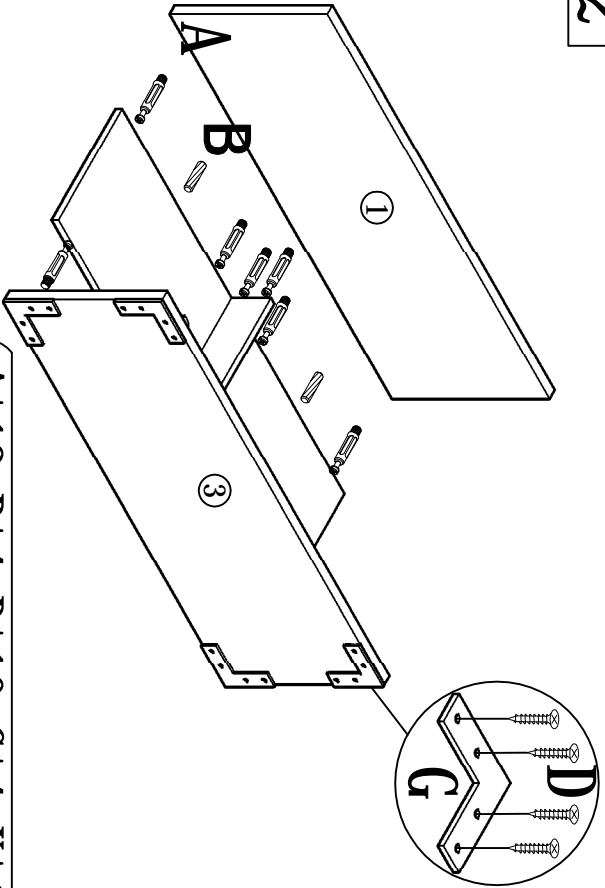

A\*12 B\*4 D\*16 G\*4 K\*12

3

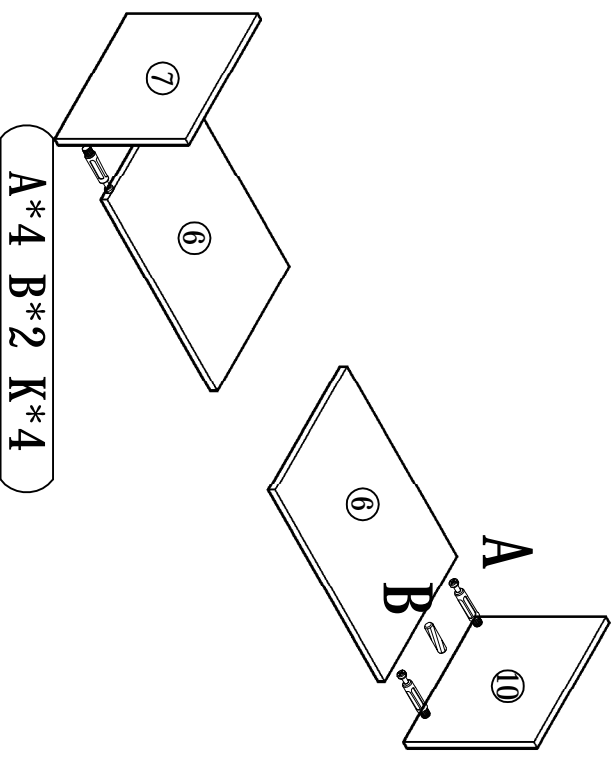

A\*4 B\*2 K\*4

4

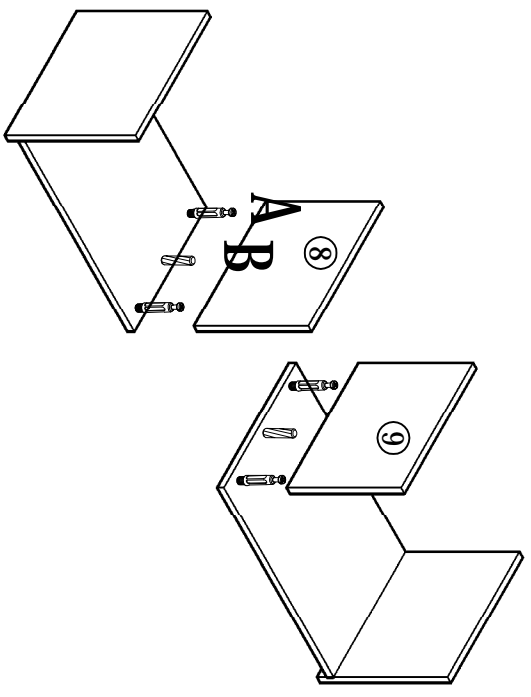

A\*4 B\*2 K\*4

5

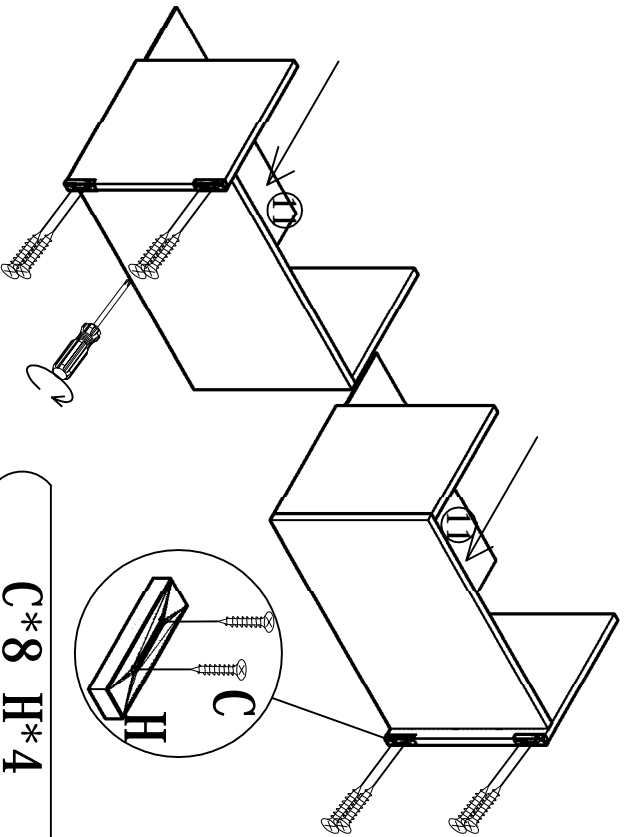

C\*8 H\*4

6

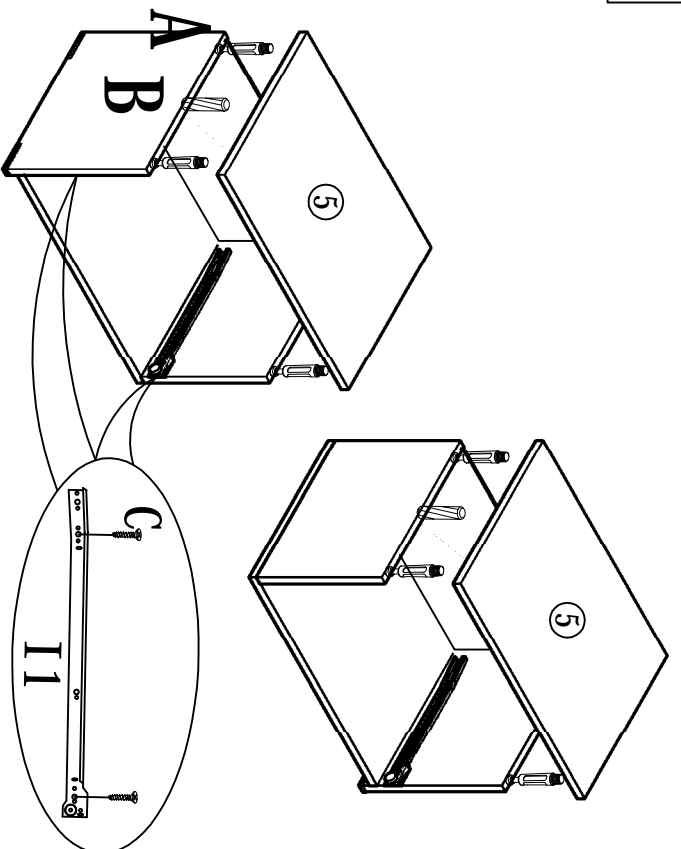

A\*8 B\*4 C\*8 I\*4 K\*8

7

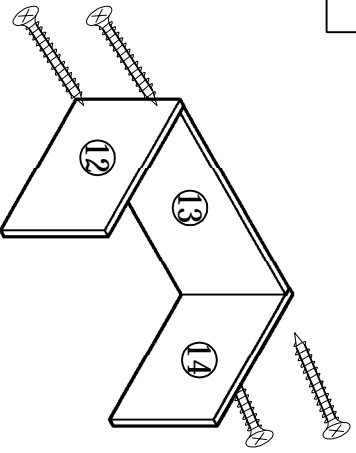

E

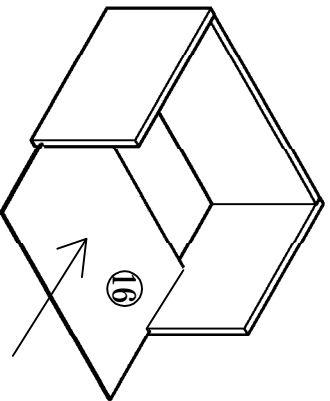

E\*4

X2

8

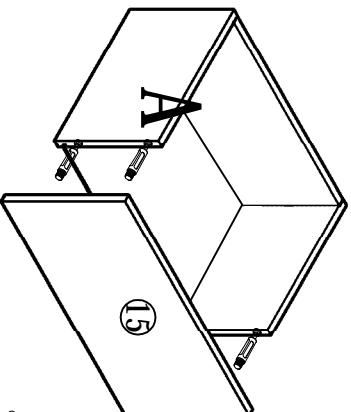

C

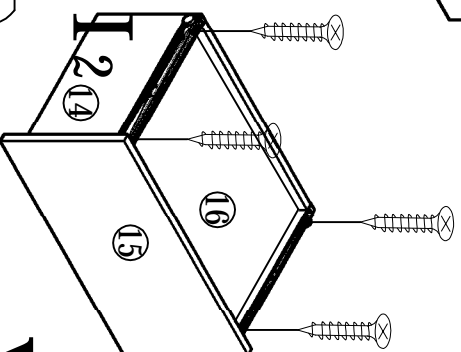

A\*4 C\*4 I2\*2 K\*4

X2

9

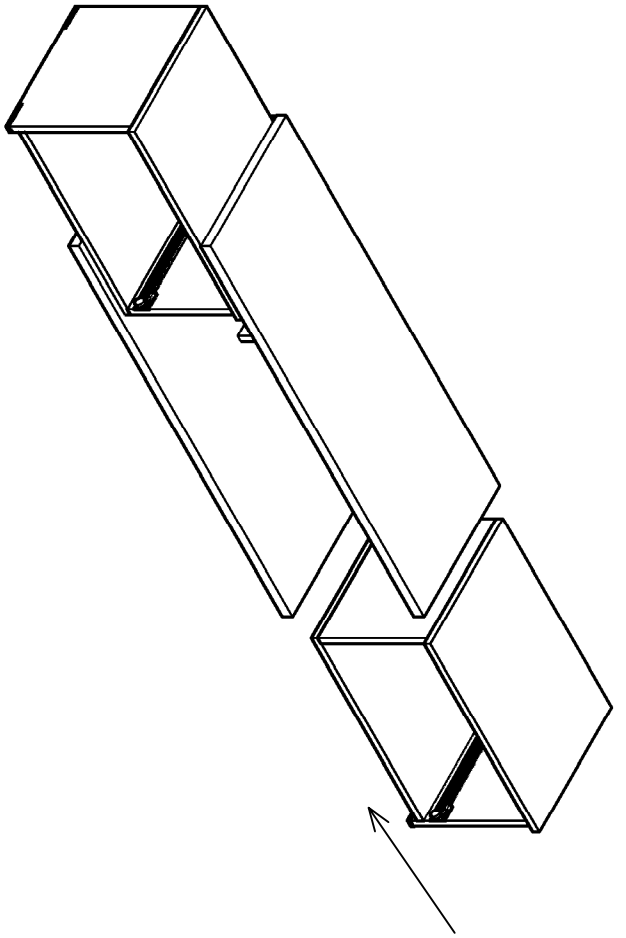

10

